

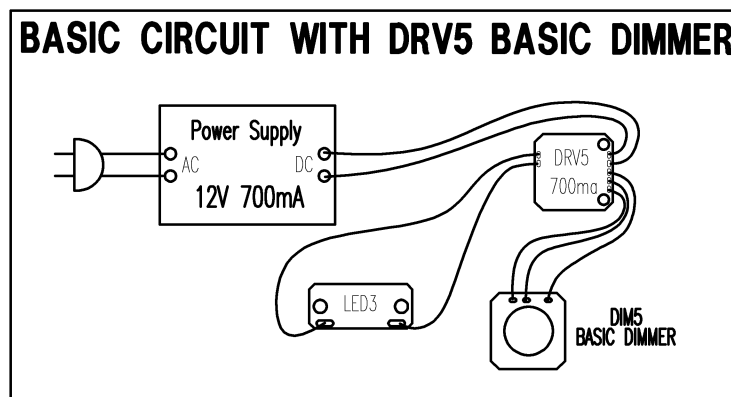

EXAMPLE CIRCUITS

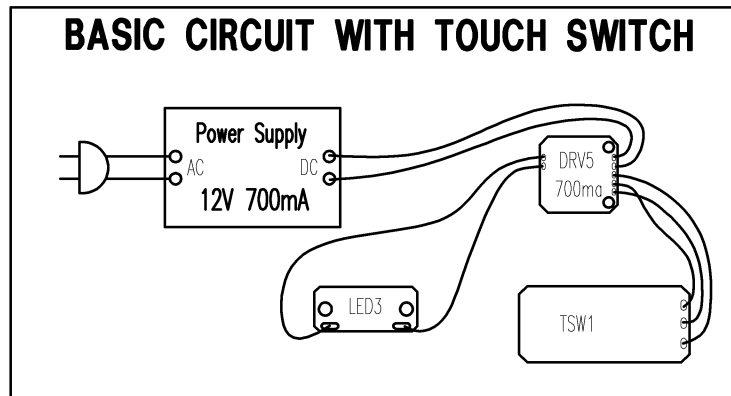

2200 LUMEN SERIES LED CIRCUIT

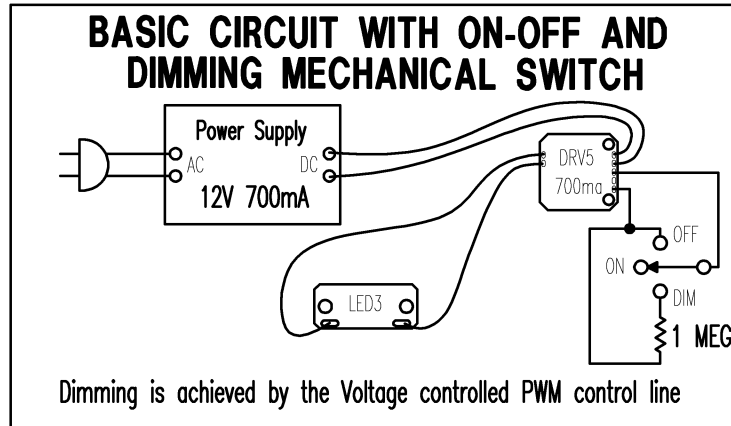
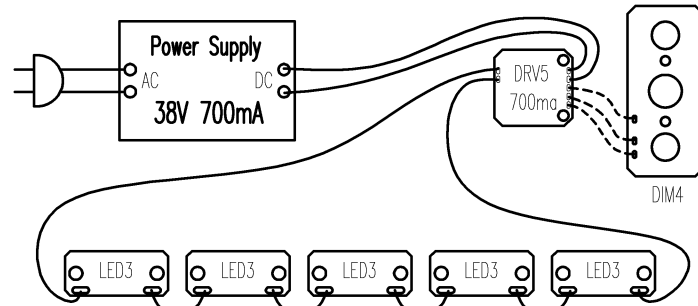

NOTE: Dimmer is not necessary. Use on-board trimmer of DRV5 to set maximum current to 700ma.

2640 LUMEN PARALLEL LED CIRCUIT

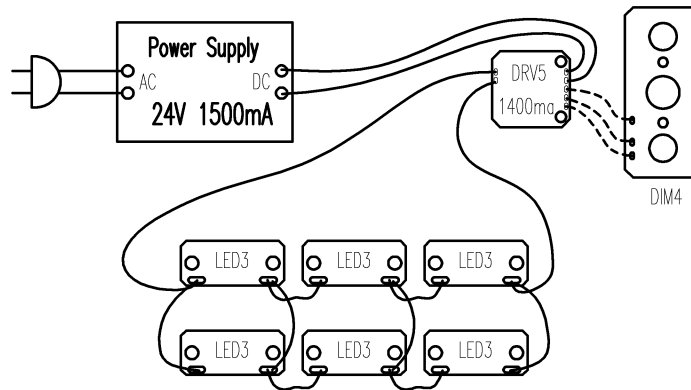

NOTE: Dimmer is not necessary. TSW1 can also be used for On-Off control.

3520 LUMEN DRV3 DIMMER/DRIVER WITH SATELLITE DRIVER(S)

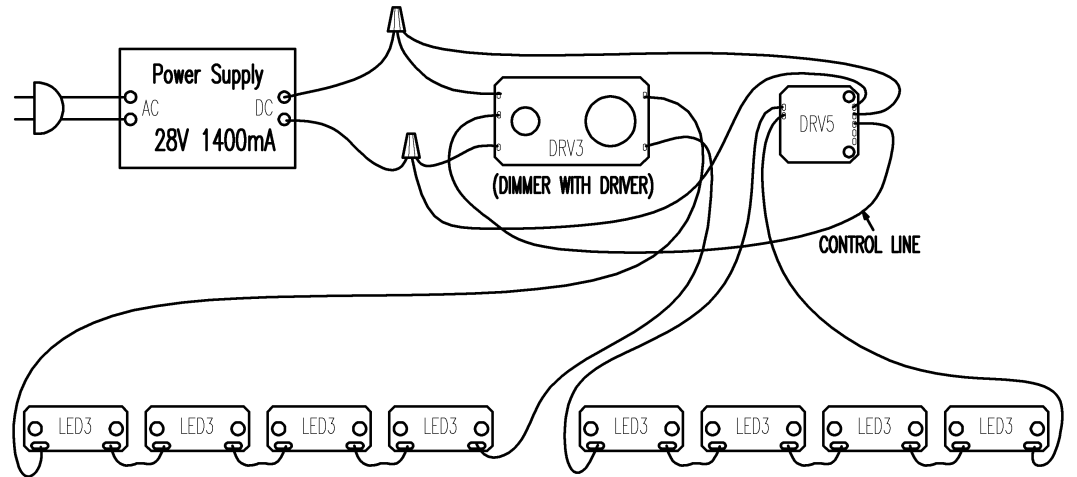

NOTE: Over 20 satellite drivers can be used with any of our dimmers.
You will need a supply with 700mA for each driver.

USING (27) 1 WATT LEDS WITH DRV5

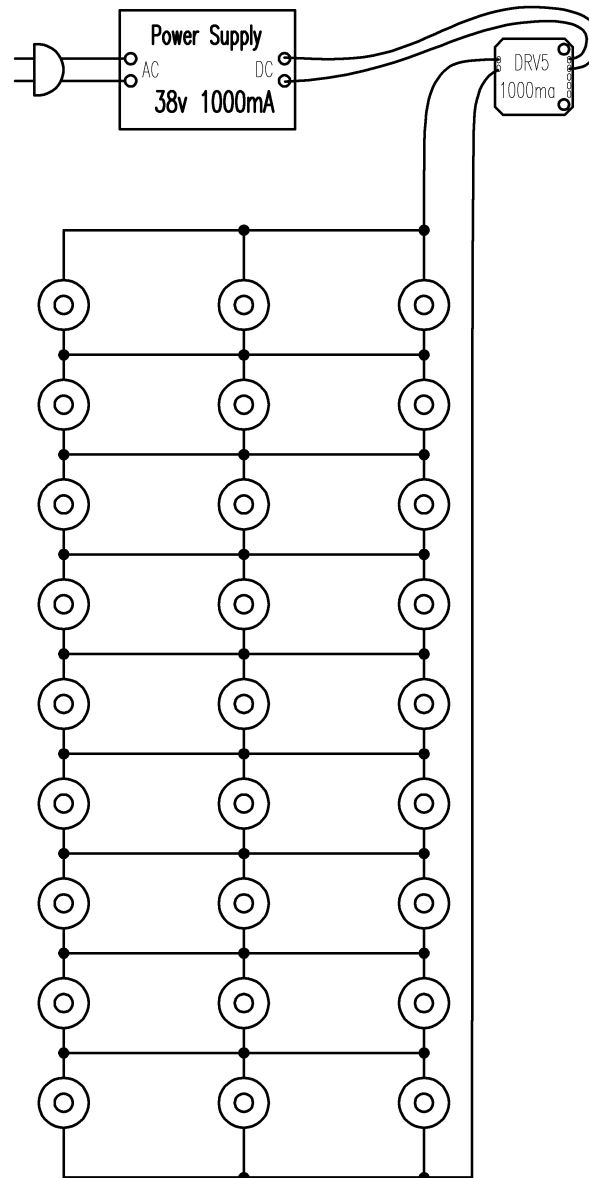

DRV-1700ADJ OR DRV-1000 CAN BE USED FOR THE ABOVE CIRCUIT